

la perfumería

de Mercadona

Have you heard
about our
SECRET
for this **CHRISTMAS?**

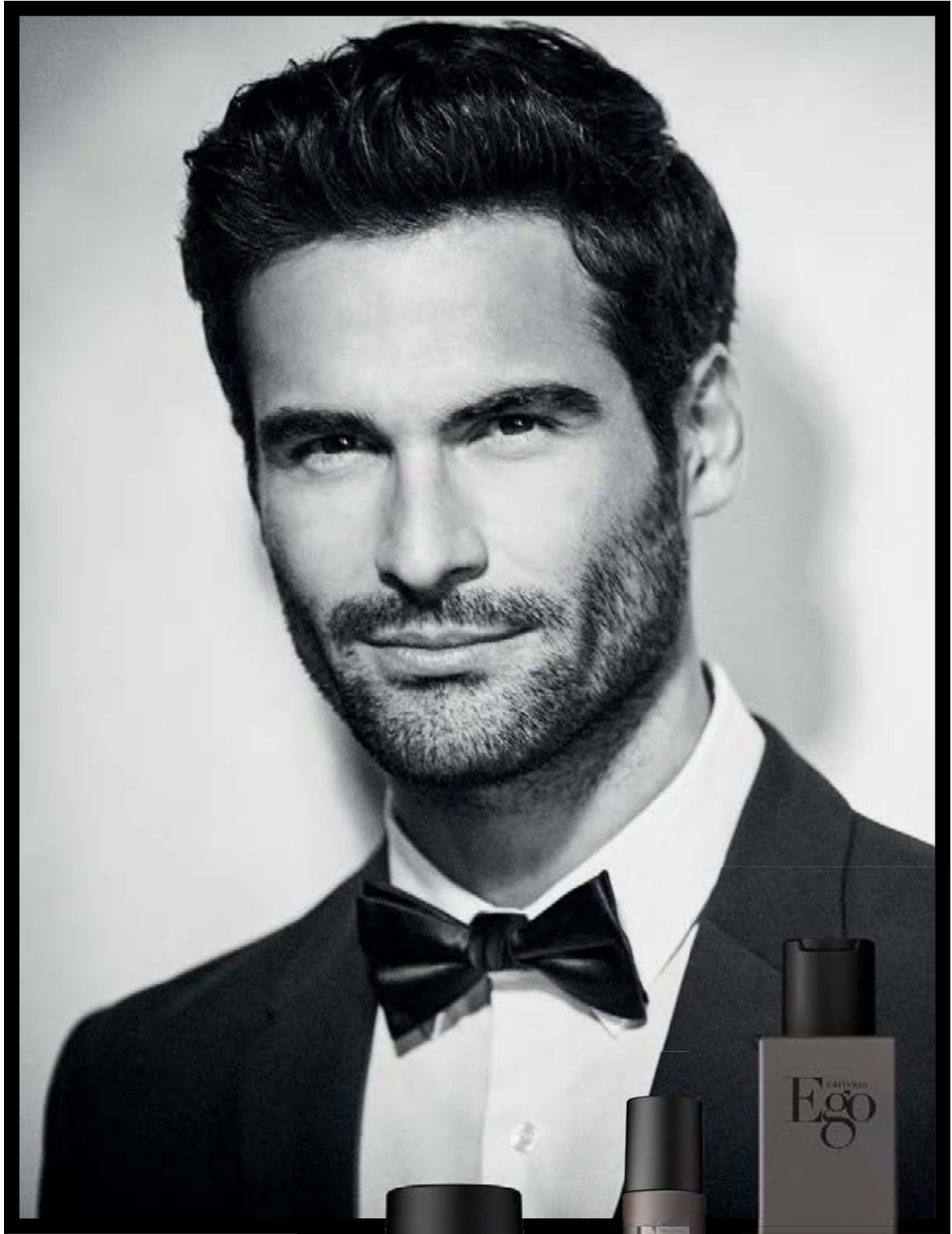

CRITERIO
Ego

SUMMARY

04 THE SECRET COSMETICS IS KEEPING THIS CHRISTMAS

12 MY SOUL

Glitter is taking over holiday make-up looks this year. My Soul, a collection designed to dazzle.

16 FOUR SEASONS

Get swept away by the colours of the My Soul eye-shadow palette and flaunt your make-up looks all year long. Let the show begin!

18 THE INVISIBLE TOUCH

When we use quality brushes, the result on your skin is noticeable almost immediately. It's one of the most powerful tools required for good make-up.

20 BLUE SHINE

Floral and fruity scents with woody touches, greater intensity and penetration, unique designs... Blue Shine has been created to sparkle.

22 MY MOMENT

Ready to find your moment and give your face and body the skin care it needs?

26 THE ART OF GIVING

Ready to dazzle and experience Christmas to the fullest? The best selection in cosmetics, beauty and fragrances.

36 I WANT IT!

Since they've been good this year, here's our special selection of Christmas gifts for kids.

Written by: MERCADONA SA
Polígono Industria I Fuente del Jarro
C/ Ciudad de Liria, 5 - 46988 Paterna / Valencia
Produced by: Ediciones ELCA
Printed by: Jiménez Godoy
Legal deposit: T0-0789-2008

The products that appear in this magazine correspond to Mercadona's standard selection of products. Some products may be unavailable due to space restrictions. Please ask our staff.

Free copy. Sale or marketing of it prohibited.
© The owner of the magazine is MERCADONA, SA.
All rights reserved. Unauthorised full or partial use and/or reproduction of the magazine, or of the brands and/or logos, is prohibited.





The Secret
Cosmetics is
keeping this Christmas
is exclusive collections
inspired by you...

MY SOUL

BLUE SHINE

my moment

EXTRATIME

The goal was clear: to make sure you had the best gifts in cosmetics, beauty and fragrances this Christmas. We started by listening to you and, after hearing your ideas, we travelled the world to find inspiration and locate the best suppliers.

Selecting excellent raw materials and the top cosmetics and container designers... has helped us achieve maximum quality in each and every one of our new collections: My Soul, Blue Shine, My Moment, Extra Time...

BLUE SHINE

MY SOUL

EXTRATIME

my moment

1. We listened to you

The first step is being attentive to your needs before shaping the collections. We met with some of you at the Cosmetics Co-Innovation Centre to ask you what you'd like to find in our stores this Christmas.



Blind tests with our specialists at the Co-Innovation Centre.





Paris

2. We travel in pursuit of excellence

We searched the world for the most prestigious cosmetics creators and designers, who chose the raw materials that helped us obtain maximum quality.



Ilias Ermenidis, perfumer from Firmenich and creator of the fragrance My Soul for him.



Philippe Paparella-Paris, perfumer from Symrise and creator of the fragrance My Soul for her.

“ Many changes have been made and meetings have been held, but the final result really pleased our creative teams and Mercadona’s alike. It was a very harmonious process. We always develop really great creations in collaboration with the client. ”



3. We work with fine materials selected at the source

Developing a perfume entails coordinating a large working group including chemists, fragrance evaluators and perfumers. The role of the evaluator is essential to the process, as they accompany the perfumer during the creation of the fragrance and operate as a nexus between their creativity and consumer taste.



▲ Ilias Ermenidis with the fragrance evaluator Ina Mexia at the Firmenich Paris offices, testing the notes of the fragrance My Soul for him.



◀ Bergamot orange combined with pink pepper and a touch of lavender provide the vibrant notes at the heart of My Soul for him. Patchouli, Haitian vetiver, sandalwood, cedar and amber form the base of the perfume.



◀ Philippe Paparella and the fragrance evaluator Ilana Kahn in the process of creating the My Soul for her fragrance. ▶



“ I developed a blend of white flower over Arabian jasmine, adding neroli, an essential oil with a very intense and persistent note of orange blossom. ”



4. We design collections made to last

You inspired us with colours: the green of mistletoe and the Christmas tree and the gold that envelops the magic and twinkles at this special time of the year. We used these tones to create a sophisticated bottle containing the aroma of Christmas.

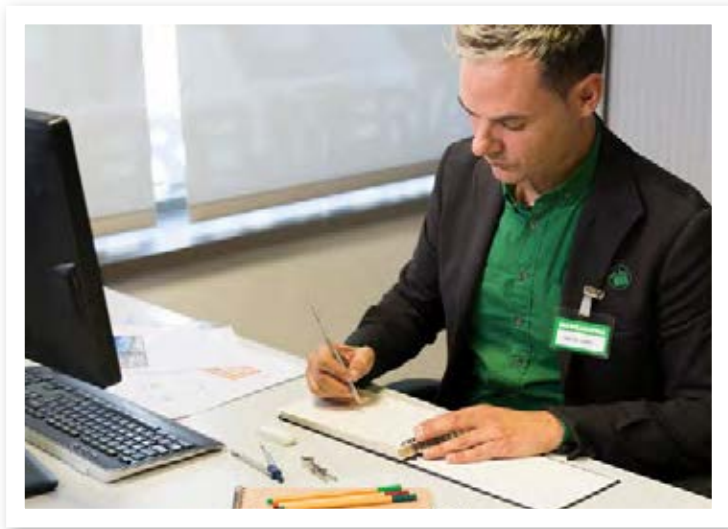

The cosmetics specialist designing the My Soul eye-shadow palette.

To keep this secret, we create different designs to get unique containers for our creations.

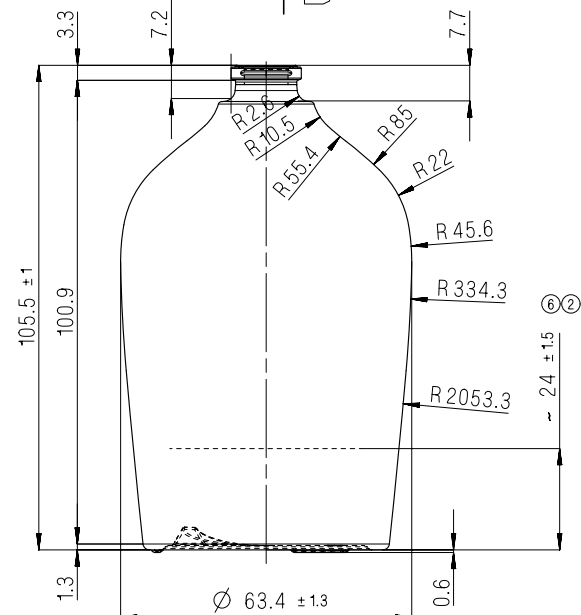
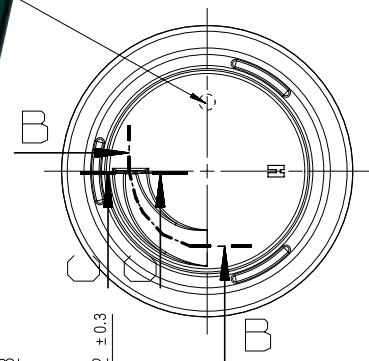

The sketches and colour schemes for the container design.



5. We shared the final result with you

Once the collections are created, our greatest satisfaction is in sharing them, finding out your opinions about them, and seeing them actually meet those expectations.

All our products are tested by a wide range of people because we know that our customers' experience represents our wisdom, and because giving them what they want is what makes us truly happy.



We want to know if the outcome is what you hoped for, if you find it easy to apply the eye-shadows, if the brushes are useful make-up tools, if the colours are the right ones, or if you immediately recognise the aroma that inspired us to create your perfume...



The **My Soul** nail polishes reflect the elegance of a party under the glow of Christmas lights. The golden applicator brush makes it a breeze to paint your nails yourself, and the burgundy, red and glitter colours reflect your suggestions.





la perfumería
THE SECRET

Blue Shine for him is a Mediterranean perfume concept with a long-lasting aroma based on fruit, floral and woody scents.

Extra Time is urban, like you, powerful and young, for him and for her, and above all, to share with friends because... "You really need a day between Saturday & Sunday".

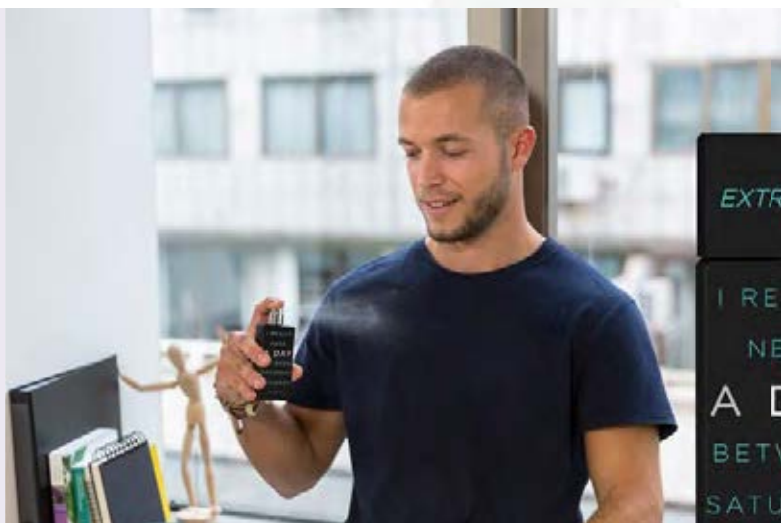

We'd love you to invite us over and tell us how you apply the products and what effects they have on your skin... If you like the texture, if they work, if they're easy to apply...

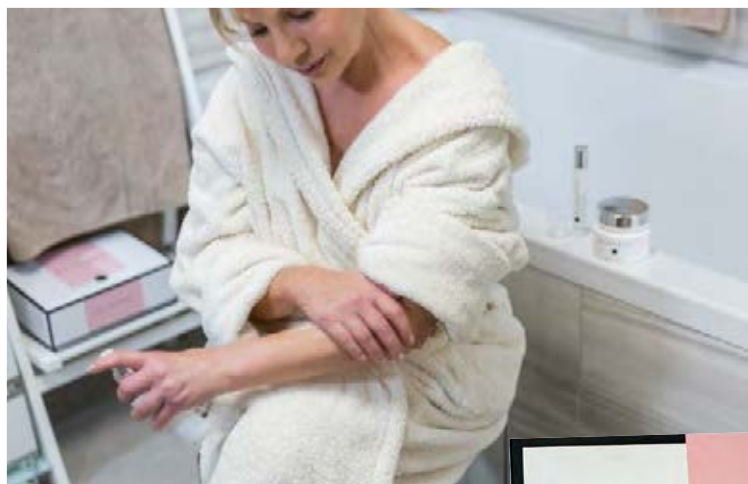

My moment is the result of many conversations, comparative studies, and user trends. It responds to that moment of relaxation we're all looking for to create our beauty moment.



MY SOUL



Glitter is taking
over holiday
make-up looks
this year.
MY SOUL
a collection
designed to
dazzle.



Pearl lipstick no. 01 in metallic red



Pearl lipstick no. 02 in metallic burgundy



Pearl eye-shadow palette



Pearl highlighter



Matte lipstick no. 01 in classic red

 This shiny collection has many secrets: The two pearl lipsticks in red and burgundy have a glitter finish to evenly spread the sparkle for maximum shine. The highlighter is baked powder with a luminous finish, making it stronger and providing a smooth glow. The nail polish lid makes it easy to use. Give it a try!



Nail polish no. 905 in glitter



Satin eye-shadow palette



Nail polish no. 903 in pearl burgundy



Nail polish no. 904 in pearl red



Eyeliner no. 301 in black with gold glitter

Lip liner no. 401 in matte red

MY SOUL



GOLDEN NIGHT

You don't need to wait for Christmas to put on a sparkly dress and special make-up, do it today! It's a good day to celebrate!

BEAUTY TIP
The highlighter was created to illuminate the face and body, in this case the cheeks and neckline. It's best to apply it using a powder brush or your fingertips to create points of light.



The model is wearing: Pearl eye-shadow palette, eyeliner no. 301 in black with gold glitter, Pearl lipstick no. 02 in metallic burgundy, Blush no. 03, Pearl highlighter, Longitud Xtrem mascara, no. 903 nail polish in pearl burgundy.

Let's Celebrate!

Elegant matte red lips, a good foundation and striking eyes. This Christmas, take a chance and triumph.



la perfumería
THE SECRET

The model is wearing:
Satin eye-shadow palette,
eyeliner no. 301 in black with
gold glitter, matte lipstick no. 01
in classic red, lip liner no. 401
in matte red, Blush no. 03, Pearl
highlighter, Longitud Xtrem
mascara, no. 904 nail polish in
pearl red and no. 905 in glitter.

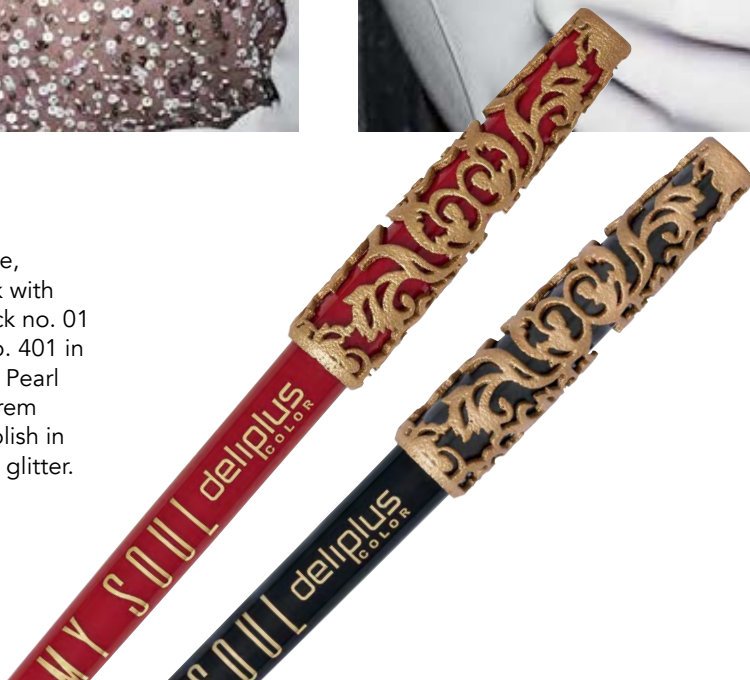

DID YOU KNOW...?

Liners have a creamy texture and a lid that sharpens the tip of the pencil when you close it.



Summer



Autumn

4 SEASONS OF COLOUR



Spring



Winter

Get swept away by the wide range of colours in the My Soul eye-shadow palette and flaunt your make-up looks all year long.

The palette contains twenty eye-shadows with matte, satin and pearl finishes to wear during all four seasons of the year. It also has a highlighter and a duo eyeliner with a creamy texture, in medium brown and deep black. Perfect for easy contouring, lining and blending. Let the show begin!



Autumn Four-season palette with Autumn eye-shadows, Duo eyeliner, Blush no. 02, Creamy lipstick no. 05 and Longitud Xtrem mascara.

Winter Four-season palette with Winter eye-shadows, Duo eyeliner, Blush no. 02, My Soul matte lipstick no. 01 in classic red and Longitud Xtrem mascara.

Summer Four-season palette with Summer eye-shadows, Duo eyeliner, Blush no. 02, Lip gloss no. 09 and Longitud Xtrem mascara.

Spring Four-season palette with Spring eye-shadows, Duo eyeliner, Blush no. 02, Creamy lipstick no. 03 and Longitud Xtrem mascara.

 The eye-shadow palette, from the My Soul collection, comes in a special chest that you can use to hold your jewellery or make-up. You can take it out and bring it with you, then use its mirror to touch up at any time. Its design is inspired by nature. **A bonus:** inside there is a pamphlet with various looks to inspire you.



MY SOUL



The model is wearing:
Pearl My Soul eye-shadow palette, My Soul eyeliner no. 301 in black with gold glitter, Pearl My Soul lipstick no. 02 in metallic burgundy, My Soul lip liner in matte red, Blush no. 03, Pearl My Soul highlighter, Longitud Xtrem mascara, My Soul no. 903 nail polish in pearl burgundy and no. 905 in glitter.

THE Invisible touch

When using **quality brushes**, the result on your skin is noticeable almost immediately. It's one of the most powerful tools required for good make-up.

Shhh... The brushes have wooden handles, making them more resistant to bumps and drops. The professional touch? The brushes come in a cute holder so you can have them on hand while using them and bring them with you anywhere.



Here are some of the brushes you need for applying make-up, but you can also use your fingers to apply concealer and highlighter to your face.

The **My Soul make-up brush holder** consists of:

- 1** The powder brush, with a larger head to help perfectly blend loose and compact powders on your face.
- 2** The make-up brush, with a perfect shape for applying products on your face.
- 3** The eye-shadow blending brush, for your eye make-up.
- 4** The angled eye-shadow brush, used to contour and line the eyes.



BLUE SHINE

Floral and fruit scents with woody touches, greater intensity and penetration, unique designs...

Blue Shine has been created to sparkle.



◀ **Blue Shine body**
Bath soap, refresh your skin with Blue Shine bath gel, body serum that hydrates and soothes, and exfoliating body scrub for all skin types.

🔒 Shall we dream? The Blue Shine collection is inspired by the idea of a coastal getaway. The image of the blue tiles of Santorini, the ceramic tiles in shades of blue and yellow of the Amalfi coast, linen shirts, jute sandals, and the powerful presence of the sea were ever-present in the creation of these fragrances that bring the Mediterranean spirit into an urban context.



▲ **Blue Shine for her**
Eau de parfum, body oil and eau de parfum spray.



◀ **Blue Shine for him**
Eau de parfum, after shave and eau de parfum spray.

My moment

Ready to find your
moment and give your
face and body the skin
care it needs?



body

Protect, hydrate, and perfume. The body scrub with micronised pearl powder enriched with camellia oil contains hydrating and rejuvenating properties for the skin. Apply it in a massaging circular motion then rinse with warm water. Then the creamy body lotion for deep nourishing... And the pillow spray can be used all over your body, hair or pillows.

face

It is a one-month advanced cosmetic programme based on the concept of chrono-cosmetics, the science that treats the ageing of skin cells by providing active concentrates to fight the visible signs of ageing. Two rituals: protection and repair during the day, and nourishment, repair and regeneration at night..

MORNING BEAUTY RITUAL ☀️

STEP 1. Use a cotton ball to apply the tonic by smoothly wiping it over your face, neck and chest.
STEP 2. Take one dose of cream and spread it on your face, neck and chest. Massage it in.

NIGHT BEAUTY RITUAL 🌙

STEP 1. Use a cotton ball to apply the tonic by smoothly wiping it over your face, neck and chest.
STEP 2. Take one dose of cream and spread it on your face, neck and chest. Massage it in.
STEP 3. Start the first session using the ACTIVE 1 COLLAGEN dropper every day for a week. Put 8 drops in the palm of your hand and mix it into the cream.
STEP 4. Gently massage the product into your face, neck and chest.

Continue in the following weeks with the quantities indicated on the ACTIVE dropper, using one per week.





EXTRATIME



The art OF GIVING

Ready to dazzle
and experience Christmas to the fullest?
The best selection in cosmetics, beauty and fragrances.







ELLA
EAU DE PARFUM
POUR FEMME



Soplo Intense
Eau de toilette with sachet, perfume spray and vanity case, musky floral notes.

Ella
Eau de parfum, eau de parfum in 20 ml. and body milk. An idea: You can reuse the box for...



Discover
our perfumes that have been carefully created and developed with aromatic notes just for you



White Flowers Floral
Bouquet Chapter Eau de toilette, bath gel and body milk.



Clutch body mist
Body mist and sachet. A bonus: store the sachet with your clothes to keep your favourite garments smelling great.



Ikiru Femme
Eau de toilette, eau de toilette in 20 ml. and gel foam.



Soplo
Eau de toilette with sachet, bath gel and body milk.



Give the gift of beauty

Our facial
treatment
sets help fight
the signs of
ageing and
regenerate the
skin day and night.
Choose your
perfect combination



Selection

Eau de parfum, eau de parfum in 20 ml. and moisturising cream.



Simply Flowers - Orange blossom

Eau de toilette, eau de toilette in 20 ml. and hand cream.



Sisbela Regenerating Firming Treatment

Restructuring and revitalising anti-age cream, stimulating serum, and firming and nourishing neck-chest cream.



24K Gold Progress

Protective daytime face cream, multi-repairing night cream and eye contour.



Bulgarian Rose
Body oil, shower gel
and exfoliant.



9.60 Woman
Eau de toilette, bath
gel and body milk.

**Intense
Femme**
Eau de
toilette.



My Soul Bath Bag
Bath gel, body
cream and bath salts





Hand mousse
No-rinse mousse hand cleanser and moisturising mousse to hydrate and soften your hands.

Beauty Magic Box
Eyeliner, face stimulator, scented body oil, bath foam, hand serum, lip exfoliant, no-rinse hand cleanser and fragrance.



3 stylish details with beauty secrets inside



Sweet Beauty Set
Eau de toilette and lip balm to hydrate and protect your lips with a pleasant gourmand floral and fruity aroma.



Woody, citric, aquatic and fresh notes... A fragrance for every personality



Misty Wood Vital Essence

Eau de toilette, bath gel, deodorant and after shave.



Vido Hombre

Moisturising face cream, anti-ageing serum and eye contour.

Intense Homme
Eau de toilette.



Ikiru Homme
Eau de toilette, eau de toilette in 20 ml. and gel foam.





9.60 Man
*Eau de toilette,
deodorant and
gel-shampoo.*



Mr. Perfect
*Eau de toilette
and shower gel.*



Él
*Eau de parfum,
eau de parfum in
20 ml. and gel-
shampoo.*



Sesgo
*Eau de toilette, eau de toilette
in 20 ml. and gel-shampoo.*



Enciende for him
*Eau de toilette,
eau de toilette
in 20 ml. and
gel-shampoo.*

**Marine - Oceanic
Notes Chapters**
*Eau de toilette,
bath gel and
after shave.*



I want it!

Since they've been good this year, here's our special selection of Christmas gifts for kids.



Fancy Nancy Clancy

Eau de toilette, tiara, pom-pom key-ring and stickers.



Frozen II toiletry kit

Eau de toilette, shampoo, bath gel, body lotion and vanity kit.

Enjoy their smiles

When they open their presents they'll find their favourite characters in different beauty kids formats

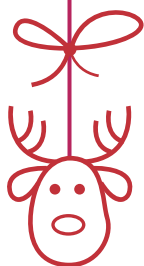

Sponge Bob

Eau de toilette and shower gel.



Frozen II

Eau de toilette, 2 lip glosses and duo eye-shadow.



Hulk
Eau de toilette, shower gel and key-ring.



Guardians of the Galaxy
Eau de toilette, shower gel and metal case.



LOL Surprise Beauty Set
Pompom key-ring, lip gloss, mirror, hair ties, hair brush and nail polishes.



LOL Surprise
Eau de toilette and shower gel.



Eau My Unicorn
Eau de toilette and shower gel figure.

Eau My Unicorn
Eau de toilette, body cream and perfume pen.



Our fragrances now come in miniature sizes
Your favourite essence, always with you



COMOTÚ PLATA. Men's *eau de toilette*, mini *eau de toilette* and multipurpose cream. COMOTÚ ORO. Women's *eau de toilette*, mini *eau de toilette* and three candles. OUD NOIR. *Eau de parfum*, *eau de parfum* mini and vanity case. ROSE NUDE. *Eau de parfum* and *eau de parfum* mini. COMOTÚ FUERZA. *Eau de toilette*, *eau de toilette* mini and gel. COMOTÚ AMOR. *Eau de toilette*, *eau de toilette* mini and body milk.

Mini SIZES AVAILABLE





MY SOUL